

HC2305

20V P-Channel MOSFET

General Description

These P-Channel enhancement mode power field effect transistors are using trench DMOS technology. This advanced technology has been especially tailored to minimize on-state resistance, provide superior switching performance, and withstand high energy pulse in the avalanche and commutation mode. These devices are well suited for high efficiency fast switching applications.

Features

V_{DS}	-20V
I_D (at $V_{GS}=-4.5V$)	-5.4A
$R_{DS(ON)}$ (at $V_{GS}=-4.5V$)	40mΩ(Max)

SOT23

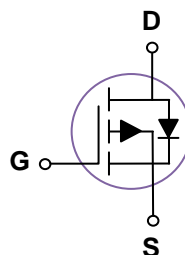
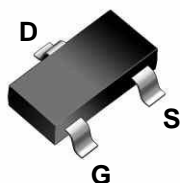

Absolute Maximum Ratings $T_A=25^{\circ}C$ unless otherwise noted

Parameter	Symbol	Maximum	Units	
Drain-Source Voltage	V_{DS}	-20	V	
Gate-Source Voltage	V_{GS}	± 10	V	
Drain Current-Continuous	TC=25°C	I_D	-5.4	A
	TC=70°C	I_D	-4.2	A
Maximum Power Dissipation	P_D	1.56	W	
Drain Current – Pulsed1	I_{DM}	-21.6	A	
Junction and Storage Temperature Range	T_J, T_{STG}	-55 To 150	°C	

Thermal Characteristics

Parameter	Symbol	Typ	Max	Unit
Thermal Resistance junction-case	$R_{\theta Jc}$		1.1	°C /W
Thermal Resistance junction-to-Ambient	$R_{\theta JA}$		80	°C /W

Electrical Characteristics (T_J=25°C unless otherwise noted)

Symbol	Parameter	Condition	Min	Typ	Max	Unit
STATIC PARAMETERS						
BV _{DSS}	Drain-Source Breakdown Voltage	V _{GS} =0V, I _D =-250μA	-20			V
I _{DSS}	Zero Gate Voltage Drain Current	V _{DS} =-20V, V _{GS} =0V			1	μA
I _{GSS}	Gate-Body Leakage Current	V _{GS} =±10V, V _{DS} =0V			±100	nA
V _{GS(th)}	Gate Threshold Voltage	V _{DS} =V _{GS} , I _D =-250μA	-0.4		-1.0	V
R _{DS(on)}	Drain-Source On-State Resistance	V _{GS} =-4.5V, I _D =-5A		32	40	mΩ
		V _{GS} =-2.5V, I _D =-4A		38	50	mΩ
DYNAMIC PARAMETERS						
C _{iss}	Input Capacitance	V _{DS} =-10V, V _{GS} =0V, F=1.0MHz		830		pF
C _{oss}	Output Capacitance			70		pF
C _{rss}	Reverse Transfer Capacitance			55		pF
SWITCHING PARAMETERS						
t _{d(on)}	Turn-on Delay Time	V _{DD} =-10V, I _D =-1A, V _{GS} =-4.5V, R _G =25Ω		6		nS
t _r	Turn-on Rise Time			21		nS
t _{d(off)}	Turn-Off Delay Time			51		nS
t _f	Turn-Off Fall Time			14		nS
Q _g	Total Gate Charge	V _{DS} =-10V, I _D =-3A, V _{GS} =-4.5V		9.6		nC
Q _{gs}	Gate-Source Charge			1.6		nC
Q _{gd}	Gate-Drain Charge			2		nC
V _{SD}	Diode Forward Voltage	V _{GS} =0V, I _{SD} =-1A		0.72	1.4	V
R _g	Gate resistance	V _{GS} =0V, V _{DS} =0V, F=1MHz		5		Ω

Note:

1. Repetitive Rating : Pulsed width limited by maximum junction temperature.
2. The data tested by pulsed , pulse width ≅ 300us , duty cycle ≅ 2%.
3. Essentially independent of operating temperature.

TYPICAL ELECTRICAL AND THERMAL CHARACTERISTICS

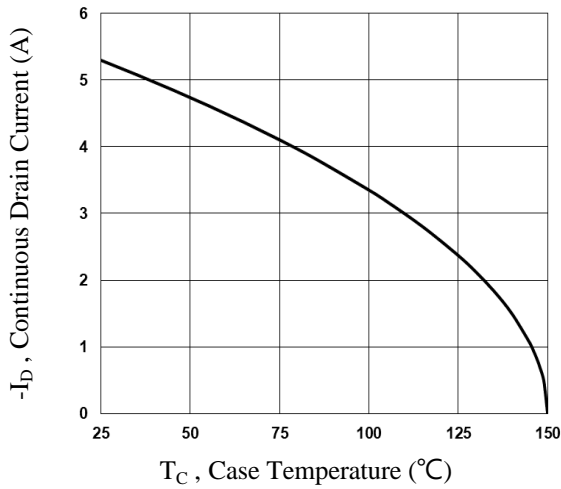

Fig.1 Continuous Drain Current vs. T_c

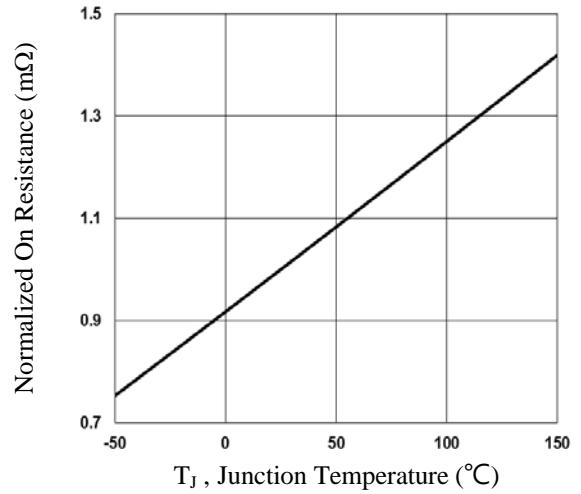

Fig.2 Normalized $R_{DS(on)}$ vs. T_j

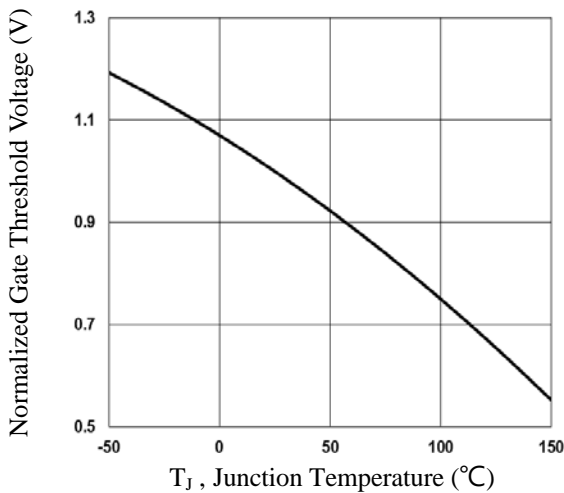

Fig.3 Normalized V_{th} vs. T_j

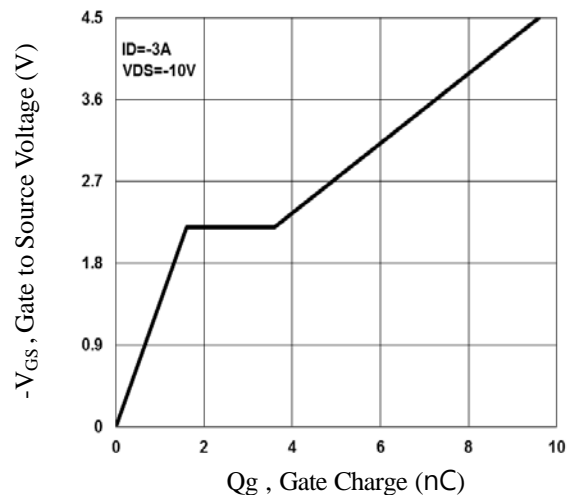

Fig.4 Gate Charge Waveform

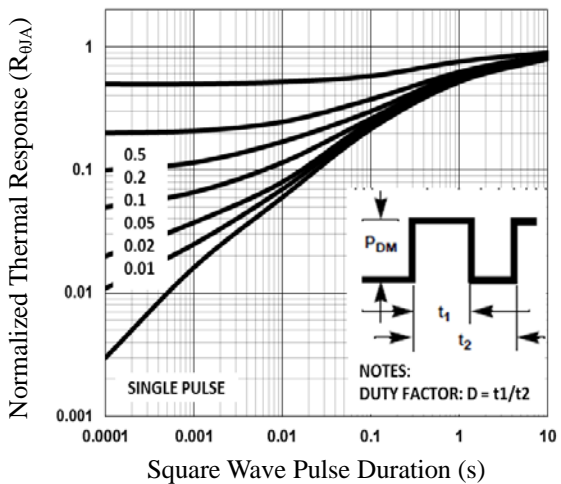

Fig.5 Normalized Transient Impedance

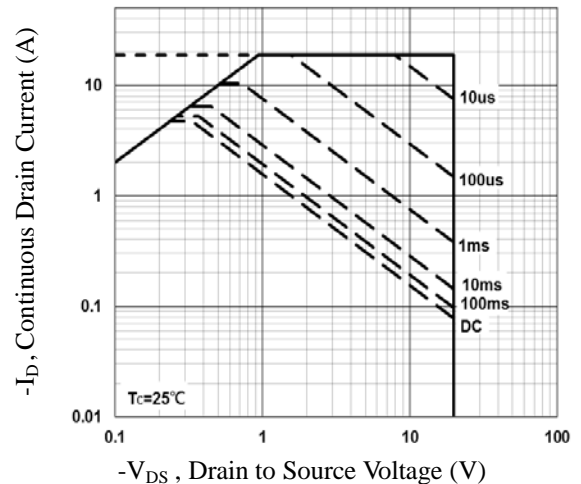

Fig.6 Maximum Safe Operation Area

TYPICAL ELECTRICAL AND THERMAL CHARACTERISTICS

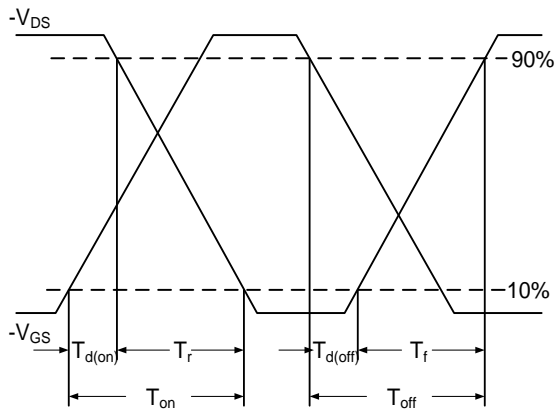

Fig.7 Switching Time Waveform

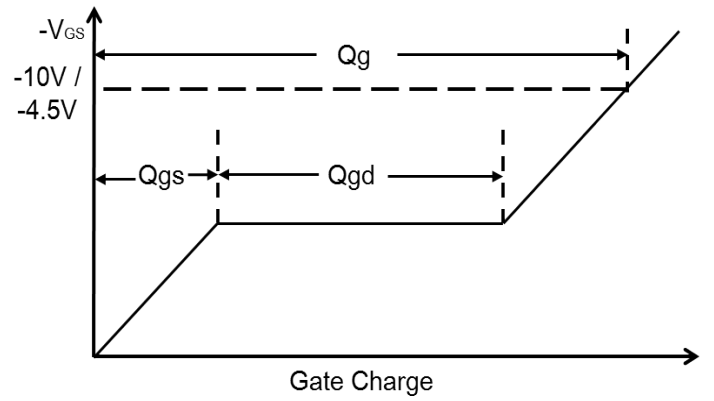
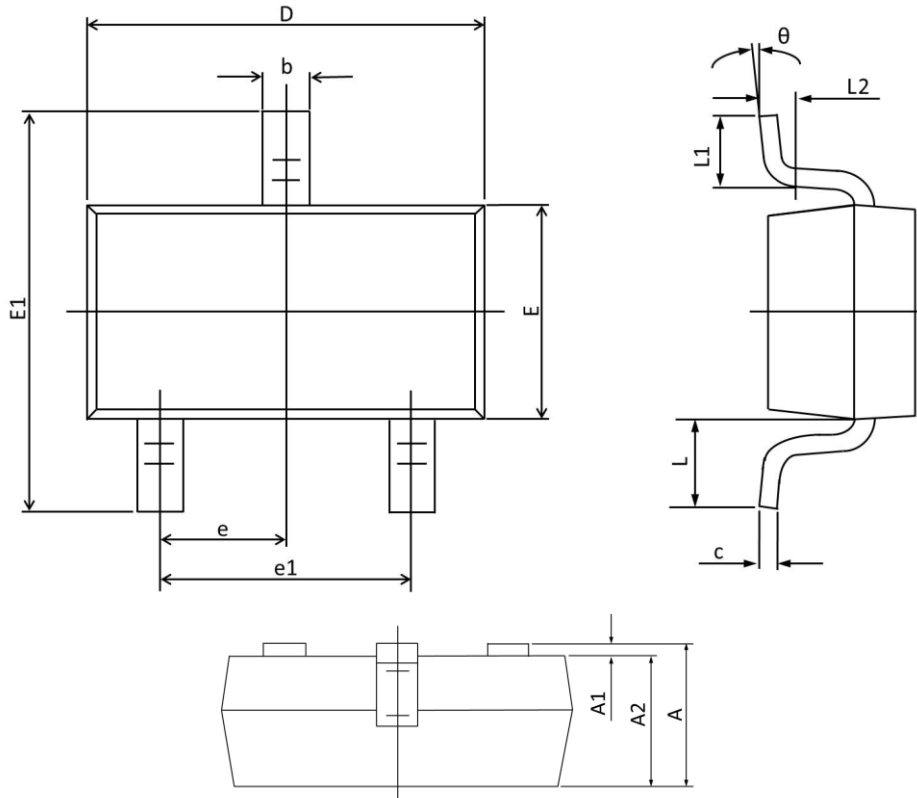

Fig.8 Gate Charge Waveform

SOT23 PACKAGE INFORMATION



Symbol	Dimensions In Millimeters		Dimensions In Inches	
	Max	Min	Max	Min
A	1.150	0.900	0.045	0.035
A1	0.100	0.000	0.004	0.000
A2	1.050	0.900	0.041	0.035
b	0.500	0.300	0.020	0.012
c	0.150	0.080	0.006	0.003
D	3.000	2.800	0.118	0.110
E	1.400	1.200	0.055	0.047
E1	2.550	2.250	0.100	0.089
e	0.95 TYP.		0.037 TYP.	
e1	2.000	1.800	0.079	0.071
L	0.55 REF.		0.022 REF.	
L1	0.500	0.300	0.020	0.012
L2	0.25 TYP.		0.01 TYP.	
θ	8°	0°	8°	0°